

UNDERBLECK FÖNSTER 40
Tj=0,6
L=1200, 1500, 2000mm
KB=85mm

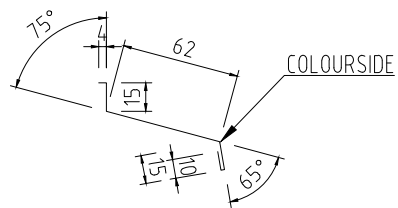

UNDERBLECK FÖNSTER 60
Tj=0,6
L=1200, 1500, 2000mm
KB=106mm

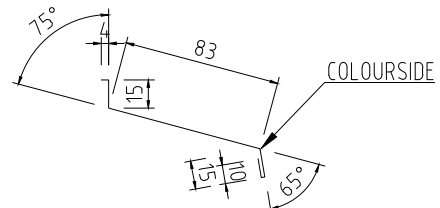

UNDERBLECK FÖNSTER 80
Tj=0,6
L=1200, 1500, 2000mm
KB=127mm

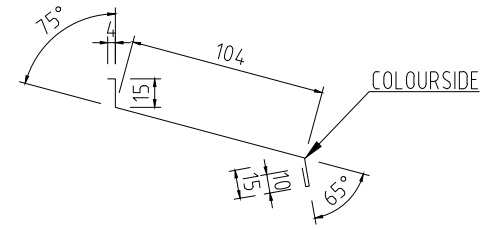

UNDERBLECK FÖNSTER 100
Tj=0,6
L=1200, 1500, 2000mm
KB=148mm

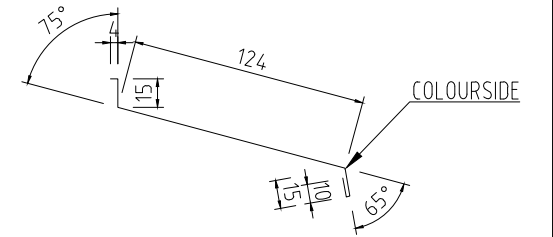

UNDERBLECK FÖNSTER 120
Tj=0,6
L=1200, 1500, 2000mm
KB=168mm

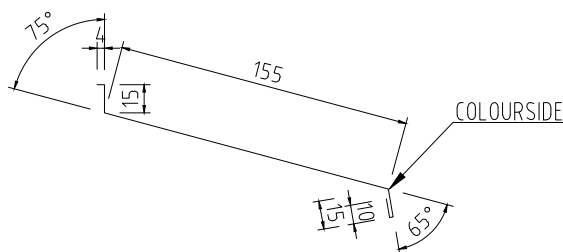

UNDERBLECK FÖNSTER 150
Tj=0,6
L=1200, 1500, 2000mm
KB=199mm

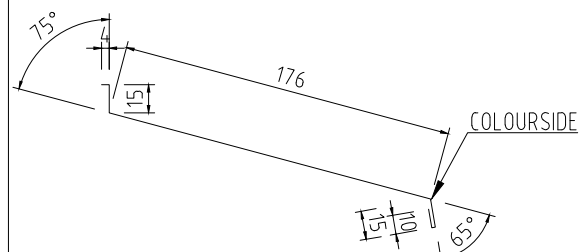

UNDERBLECK FÖNSTER 170
Tj=0,6
L=1200, 1500, 2000mm
KB=220mm

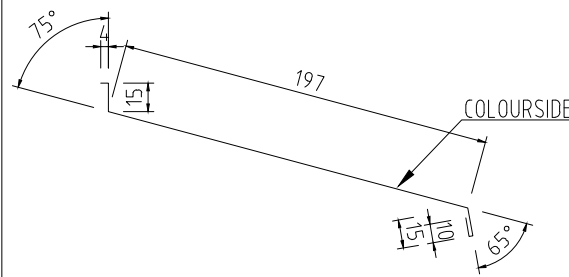

UNDERBLECK FÖNSTER 190
Tj=0,6
L=1200, 1500, 2000mm
KB=241mm

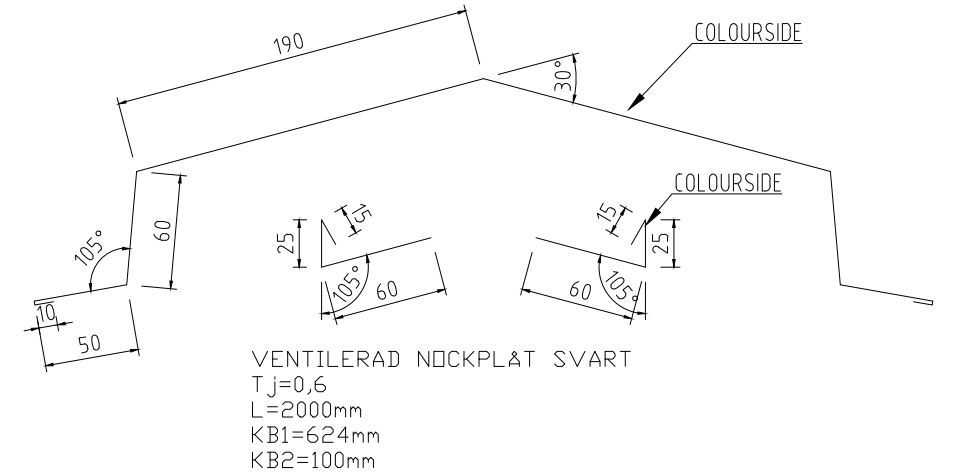

VENTILERAD NÖCKPLÅT SVART
Tj=0,6
L=2000mm
KB1=624mm
KB2=100mm

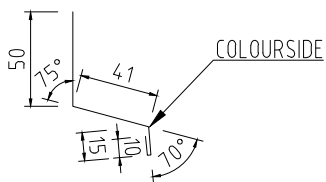

ÖVERBLECK FÖNSTER 40
Tj=0,6
L=1200, 1500, 2000mm
KB=116mm

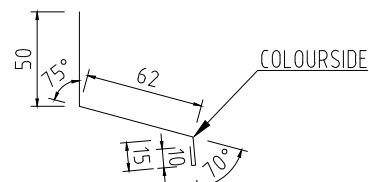

ÖVERBLECK FÖNSTER 60
Tj=0,6
L=1200, 1500, 2000mm
KB=137mm

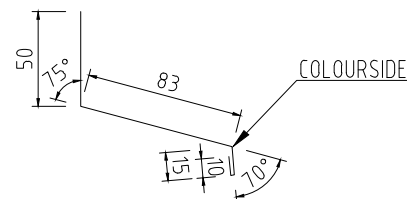

ÖVERBLECK FÖNSTER 80
Tj=0,6
L=1200, 1500, 2000mm
KB=158mm

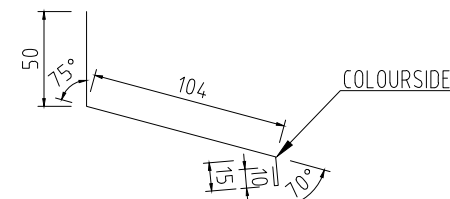

ÖVERBLECK FÖNSTER 100
Tj=0,6
L=1200, 1500, 2000mm
KB=179mm

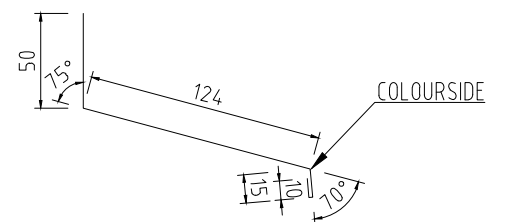

ÖVERBLECK FÖNSTER 120
Tj=0,6
L=1200, 1500, 2000mm
KB=199mm

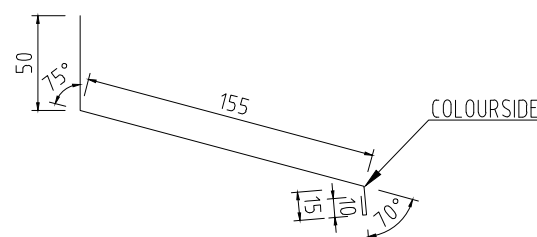

ÖVERBLECK FÖNSTER 150
Tj=0,6
L=1200, 1500, 2000mm
KB=230mm

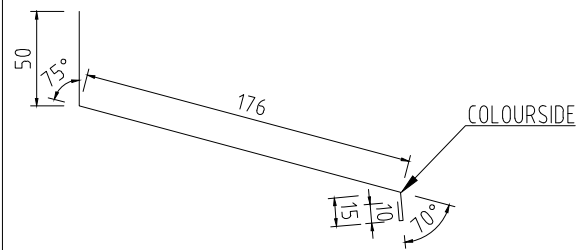

ÖVERBLECK FÖNSTER 170
Tj=0,6
L=1200, 1500, 2000mm
KB=251mm

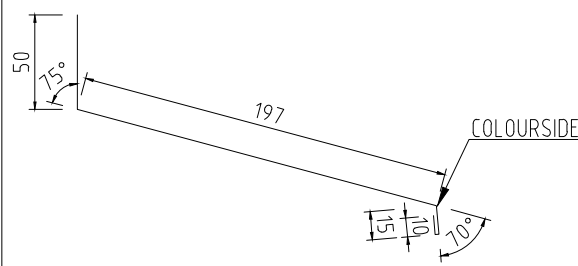

ÖVERBLECK FÖNSTER 190
Tj=0,6
L=1200, 1500, 2000mm
KB=272mm

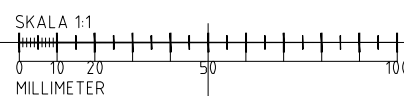

BET	ANT	ÄNDRINGEN AVSER	DATUM	SIGN
BYGGHANDLING				
Kv. KOMMUN				
Vinkelgatan 13 Telefon: +4640 698 51 00 211 24 Malmö Fax: +4640 184 171 www.areco.se Org Nr: 556266-4515				
UPPDRAG NR	RITAD/KONSTR AV		HANDLAGGARE	
DATUM	ANSVARIG			
2024-03-19	C.HAST			
BESLAG SAMMANSTÄLLNING 1/2				
PRODUKTIONSRTNING				
BESLAG				
A1	A3	NUMMER	BET	
1:1	1:2			

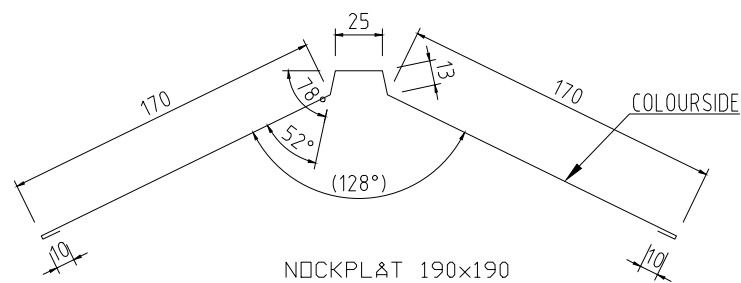

NOCKPLÅT 190x190
Tj=0,5-0,6
L=2000mm
KB=410mm

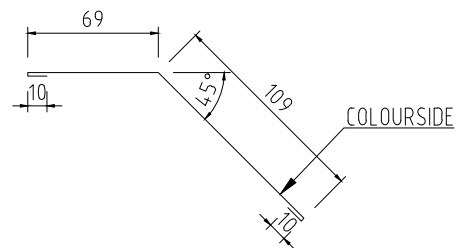

FOTPLÅT 69x109 VÄNDBAR
Tj=0,5-0,6
L=2000mm
KB=198mm

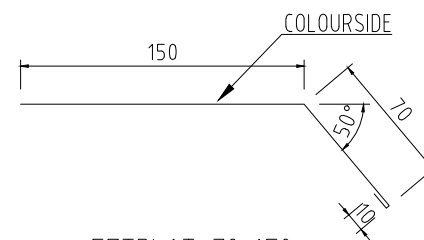

FOTPLÅT 70x150
Tj=0,5-0,6
L=2000mm
KB=230mm

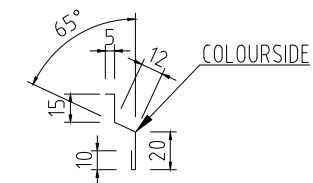

TRÖSKELBLECK 1230
Tj=0,5-0,6
L=1230mm
KB=62mm

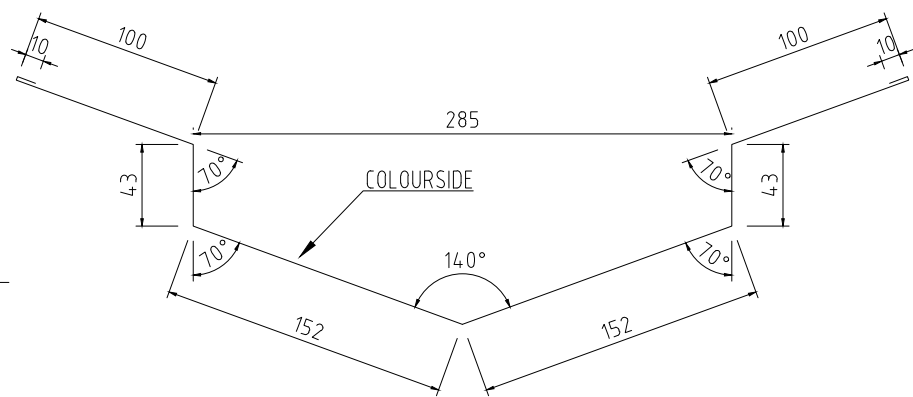

RÄNNDALSPLÅT KNÄCKT 152x152
Tj=0,5-0,6
L=2000mm
KB=610mm

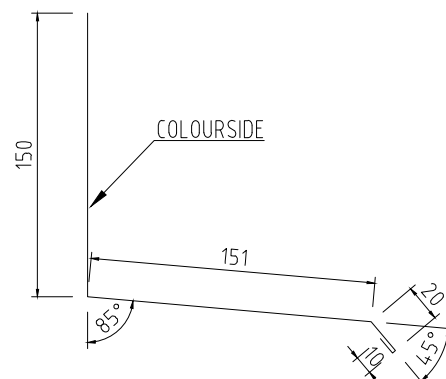

STÄNSKIVA 170x150
Tj=0,5-0,6
L=2000mm
KB=331mm

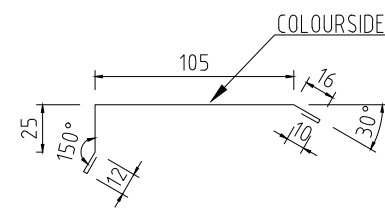

GAVELBESLAG RAK 25x105
Tj=0,5-0,6
L=2000mm
KB=178mm

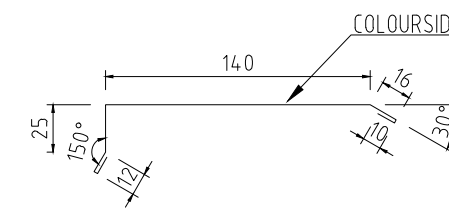

GAVELBESLAG RAK 25x140
Tj=0,5-0,6
L=2000mm
KB=213mm

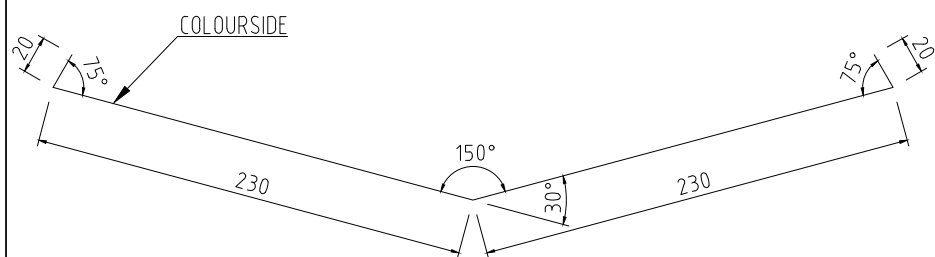

RÄNNDALSPLÅT RAK 230x230
Tj=0,5-0,6
L=2000mm
KB=500mm

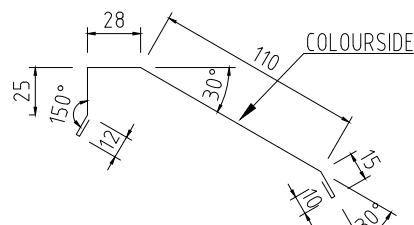

GAVELBESLAG KNÄCKT 25x28x110
Tj=0,5-0,6
L=2000mm
KB=210mm

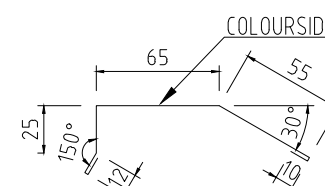

GAVELBESLAG KNÄCKT 25x65x55
Tj=0,5-0,6
L=2000mm
KB=177mm

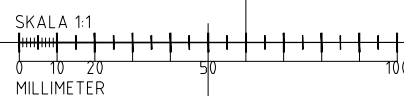

BET	ANT	ÄNDRINGEN AVSER	DATUM	SIGN
-----	-----	-----------------	-------	------

BYGGHANDLING

Kv.
KOMMUN



Vinkelgatan 13
211 24 Malmö
www.areco.se

Telefon: +4640 698 51 00
Fax: +4640 184 171
Org Nr: 556266-4515

UPPDRAG NR	RITAD/KONSTR AV	HANDLAGGARE
DATUM	ANSVARIG	

2024-03-27

BESLAG SAMMANSTÄLLNING 2/2

PRODUKTIONS-RITNING
BESLAG

A1	A3	NUMMER	BET
1:1	1:2		